

Sliding Bracket(S=1/8)

Side Bracket(S=1/8)

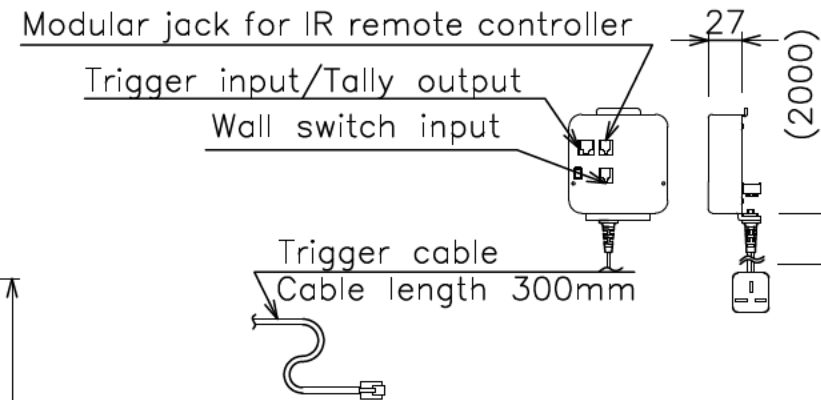

Modular type

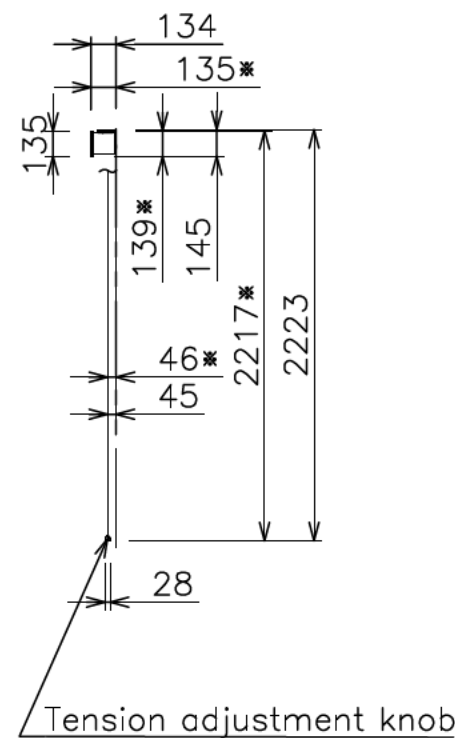
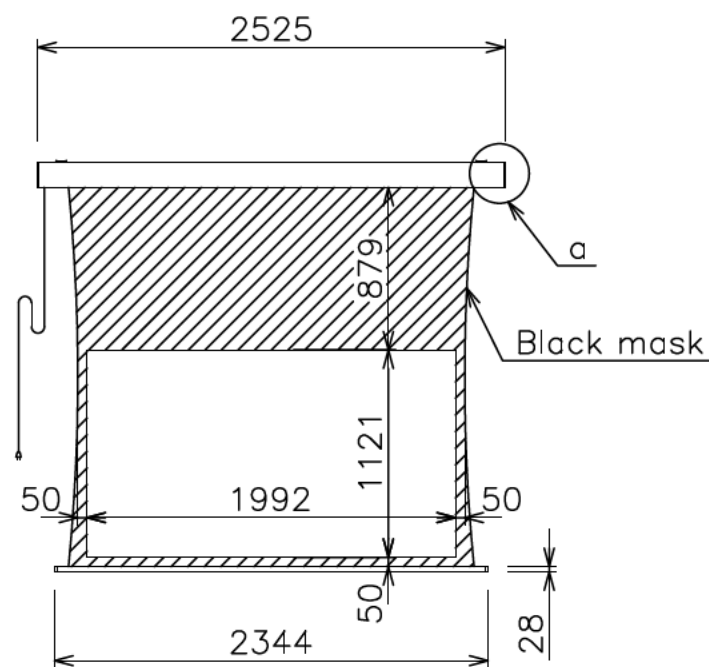
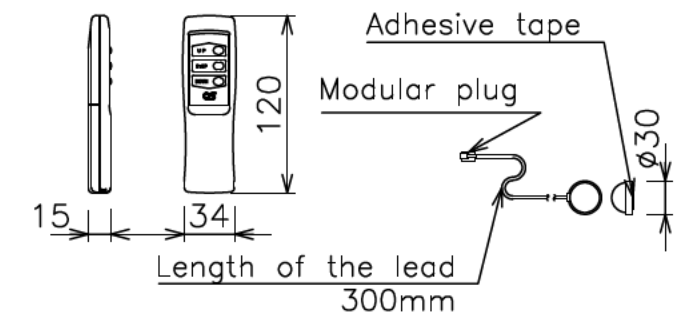

IR remote controller IR receiver

PCB box and Operation switch

Voltage	AC220V~240V
Frequency	50Hz/60Hz
Current	0.49A
Motor rated operation time	4min
Travel speed	50Hz:83 60Hz:100 (mm/sec)

Screen materials	REIRODORU(HF102)
Screen case	Symmetry case
Front panel	Color: Black Detachable
Mechanism	Tension adjustment,side tension method
Weight	16.7Kg
Accessory	IR Remote controller Transmitter/Receiver x 1 Sliding Bracket x 2 Side Bracket x 1 set Truss tapping screws with cross hole(4x40) x 6 Truss tapping screws with cross hole(4x12) x 4
Option	Wall switch(S-R2)

- Note**
- The switch box, the primary and secondary electric wirings, plumbings and wiring materials are required separately.
 - The reception sensitivity may decrease and IR range may be shortend under the inverter lighting.
 - External dimensions are rounded up after the decimal point.
 - * Size shown is with side bracket.